

Direct Screw Installation Instructions



Picture 1

Standard Parts Description (Figures A , B & C):

- A. #6 X 1 5/8" Screw (1 per perforation)
- B. #8-10 1" Anchor (1 per perforation)
- C. Screw Plug (1 per perforation) or
- D. Screw Cap - 3/8" Material Only
- E. Spacers (Optional)

1. Position Tableaux® grille in the desired position. Use a leveling device to properly position the piece. (Picture 1)

2. Holding the piece in the desired position; insert a sharp implement with an approximate 3/16" diameter (e.g. drill bit, #10 wood screw) through the holes in order to mark the desired position (Picture 2). Repeat for every mounting hole. Remove grille.

3. Drill drywall with a 3/16" drill bit (Picture 3).

- Note A: If drilling into wood use a 1/8" drill bit and skip to step 5.
- Note B: If drilling into stone or concrete, use the drill bit recommended by the screw manufacturer (screws not provided).

4. Insert plastic anchors (Picture 4). (See Note C about ceiling mounts)

5. Place the grille in the desired position. Insert and tighten all screws.

- 5.a. Optional: If using spacers, place those between grille and wall, insert screw through the hole and through the spacers (Figure C).

6. Place plugs over the screw and, if necessary, tap them carefully with a rubber hammer until flush with the grille's surface (Picture 6).

Note C - Ceiling Mount. Bigger ceiling pieces will have, in addition to the screw holes along the frame, additional screw holes throughout the design/body of the piece. Be sure to place screws in every hole provided ensure proper installation. Depending on the quality of the ceiling surface and structure you may have to use different anchoring hardware (e.g. toggle anchors) other than the standard wall mount anchors provided by the manufacturer. Make sure that at least a few strategically positioned screws are attached directly to the ceiling structural substrata. Verify that every screw is completely tightened and that every anchor is securely attached to the ceiling. A screw that does not tighten completely indicates a faulty anchor installation. In certain cases additional hardware may be required to insure a safe ceiling installation.

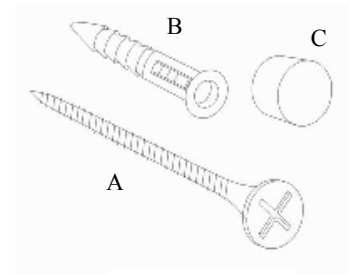

Figure A

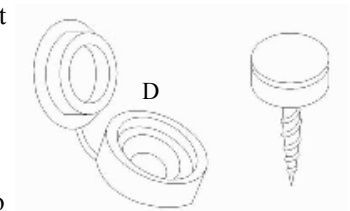

Figure B

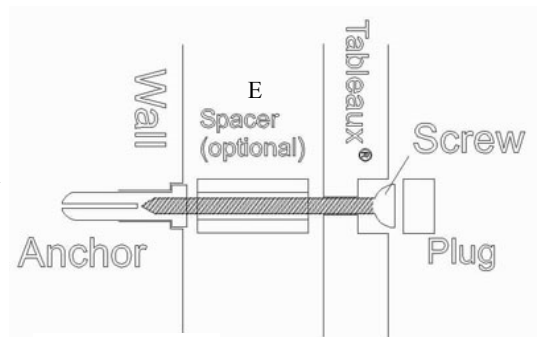
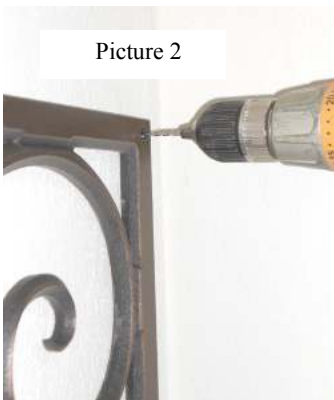
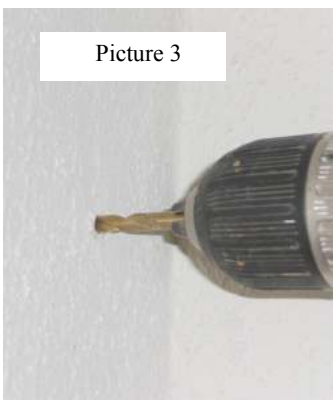

Figure C



Picture 2



Picture 3

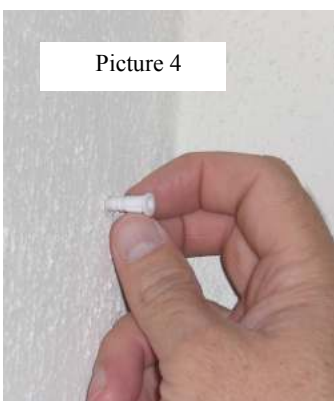

Picture 4

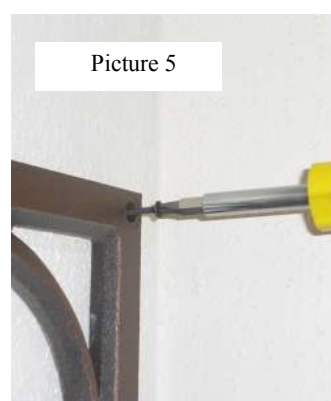

Picture 5



Picture 6